

# "Glove Only" Selection Guide

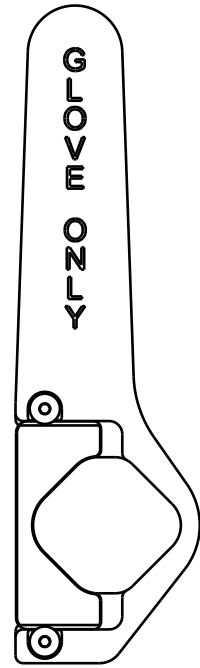

**Original**

Fits **oblong** cross sections.  
For example:

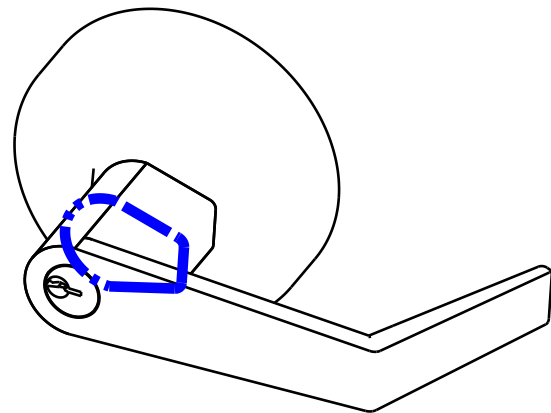

Download [Fitment Guide]

Availability: Order online at  
[www.gulchengineering.com](http://www.gulchengineering.com)

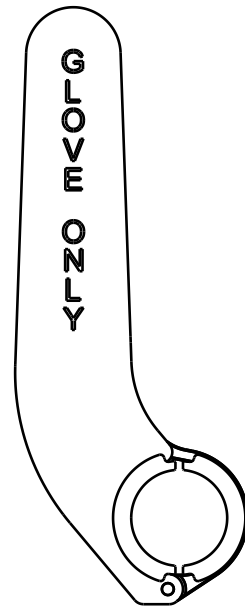

**Type 2**

Fits **cylindrical** cross sections.  
For example:

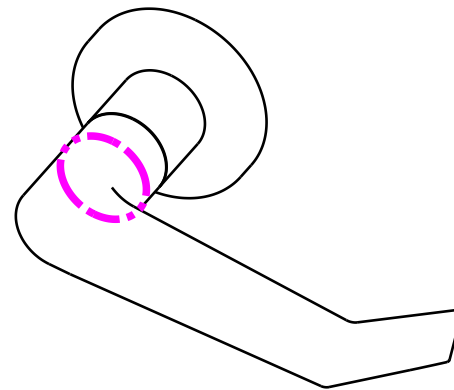

Fitment: Custom Sleeves. We will guide you through the measurements needed, or you can send us one of your door levers.

Availability: Contact Us for  
Current Lead Time

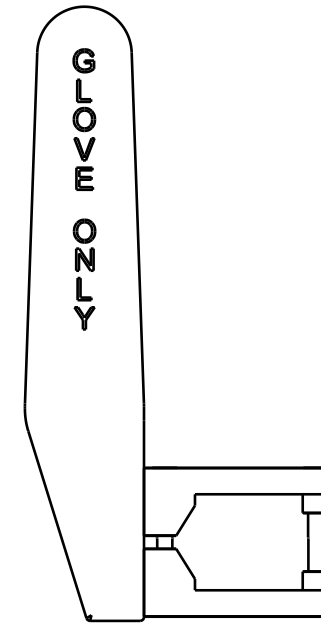

**Type 3**

Designed for levers that have little rotating stem area. For example:

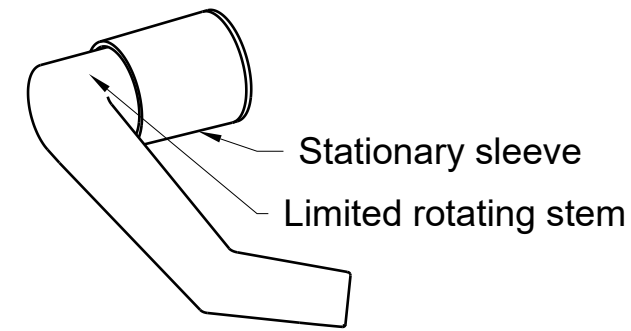

Fitment: Contact us for an assessment of your door lever. You can start with photographs of the front and top of your lever, and we'll follow up with any measurements needed.

Availability: Contact Us for  
Current Lead Time

## Opposites Convention

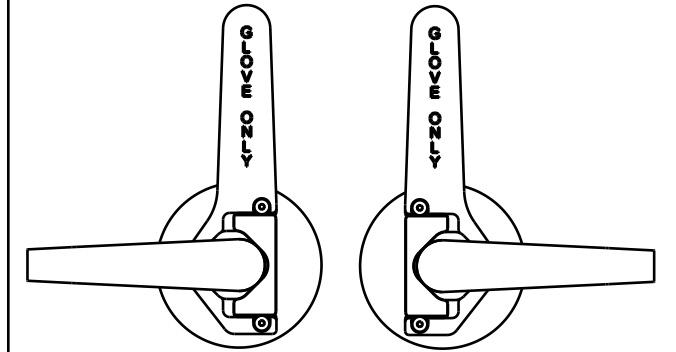

**Left Hand** fit  
door levers that  
point left

**Right Hand** fit  
door levers that  
point right

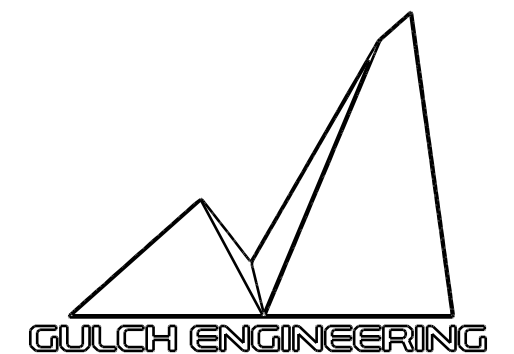

Proudly Made in Mukilteo, WA, USA  
[www.gulchengineering.com](http://www.gulchengineering.com)  
Document ID: GO\_Selection\_ - 04/03/26